

Version 2.0 2019/11
M55-4K Standard version

element™

M55-4K

Touch Monitor

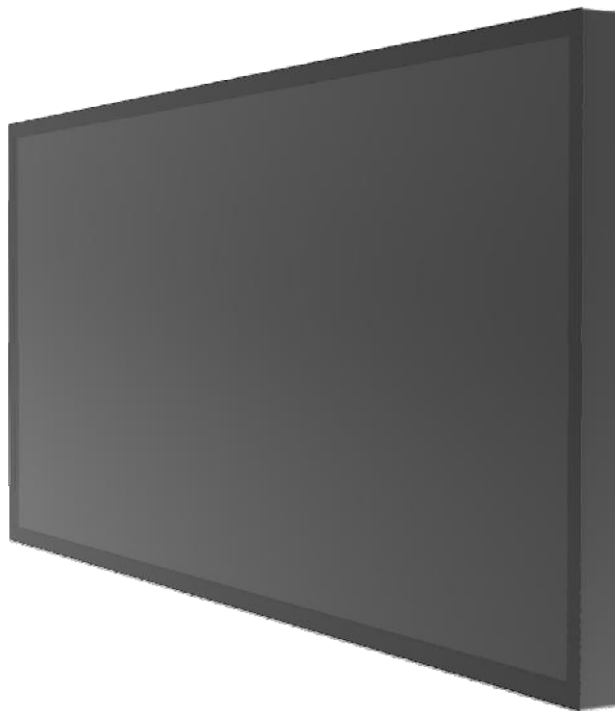

About This Document

No part of this publication may be reproduced, transmitted, transcribed, stored in a retrieval system, or translated into any language or computer language, in any form or by any means, including, but not limited to, electronic, magnetic, optical, chemical, manual, or otherwise without prior written permission of Element.

The information in this document is subject to change without notice. Element makes no representations or warranties with respect to the contents herein, and specifically disclaims any implied warranties of merchantability or fitness for a particular purpose. Element reserves the right to revise this publication and to make changes from time to time in the content hereof without obligation of Element to notify any person of such revisions or changes. Windows is a registered trademark of Microsoft, Inc. Other brand or product names are trademarks of their respective holders.

Compliance Information

For FCC (USA)

This equipment has been tested and found to comply with the limits for a Class A digital device, pursuant to part 15 of the FCC Rules. These limits are designed to provide reasonable protection against harmful interference when the equipment is operated in a commercial environment. This equipment generates, uses, and can radiate radio frequency energy and, if not installed and used in accordance with the instruction manual, may cause harmful interference to radio communications. Operation of this equipment in a residential area is likely to cause harmful interference in which case the user will be required to correct the interference at his own expense.

This device complies with part 15 of the FCC Rules. Operation is subject to the following two conditions: (1) this device may not cause harmful interference, and (2) this device must accept any interference received, including interference that may cause undesired operation.

For IC (Canada)

CAN ICES-3(A)/NMB-3(A)





For CE (EU)

The device complies with the EMC Directive 2014/30/EU and Low Voltage Directive 2014/35/EU

Warning:

This is a class A product. In a domestic environment this product may cause radio interference in which case the user may be required to take adequate measures.

Usage Notice

-  **Warning** - To prevent the risk of fire or shock hazards, and do not expose the product to moisture.
-  **Warning** - Please do not open or disassemble the product as this may cause electric shock.
-  **Warning** - Power cord shall be connected to a socket-outlet with earthing connection.
-  **Warning** - The cable cover cannot be removed under normal use conditions.
-  **Warning** - **Stability Hazard.** The touch monitor may fall, causing serious personal injury or death. To prevent injury, this touch monitor must be securely attached to the wall in accordance with the installation instructions.

Precautions

Please follow all warnings, precautions and maintenance as recommended in this user's manual to maximize the life of your unit.

Do :

- Turn off the product before cleaning.
- Use a soft cloth moistened with mild detergent to clean the product housing.
- Use only the qualified power adapter that comes with your device.
- Disconnect the power plug from AC outlet if the product is not going to be used for an extended period of time.

Don't :

- Do not use abrasive cleaners, waxes, or solvents for your cleaning.
- Do not operate the product under the following conditions:
 - Extremely hot, cold, or humid environment.
 - Areas susceptible to excessive dust and dirt.
 - Near any appliance generating a strong magnetic field.

Table of Contents

Chapter 1.....	7
1.1 Overview	8
1.2 Feature	8
1.3 Specifications	8
1.4 Block Diagram	9
1.5 Interface Connectors.....	9
1.5.1 Power Connector.....	9
1.5.2 Video Signal Connector	10
1.5.3 Signal Connector.....	11
1.6 Package Overview	13
Chapter 2.....	14
2.1 About VESA Mount	15
2.1.1 Install the VESA screw	16
2.2 About General Mounting Information	17
2.2.1 Landscape.....	17
2.2.2 Portrait	17
2.3 On-Screen Display	17
2.3.1 OSD Function Description.....	19
2.3.2 Timing Table Chart.....	20
2.3.3 EDID Data	20
2.4 Dimension	21
2.4.1 Front View	21
2.4.2 Side View	21
2.4.3 Rear View	22
2.4.4 Back View	22
Appendix.....	23

Chapter 1

Product Introduction

1.1 Overview

The M55-4K Series is a 55" large size thin-film transistor (TFT) liquid crystal display (LCD). This unit is to be used as commercial and light industrial equipment only.

1.2 Feature

- 4K2K High Resolution Display
- Dynamic Touch Sensitivity Technology Supports up to 6mm Thickness glass
- Portrait and Landscape Display for All Solutions
- Touch Screen Support up to 40 Points Touch
- Supports 24/7 non-stop Operate Service

1.3 Specifications

LCD Touch Panel	
Size	55" TFT LCD
Brightness	450 cd/m ² (non-touch screen) 383 cd/m ² (P-CAP)
Number of Pixels	3840(H) x 2160(V)
Touch Type	P-CAP/ 40 points
Environment	
Power Input	AC 100-240V ~ 1.8-0.8A 50-60Hz
Power Output	5VDC, 2A
Operating Temperature	0°C ~ 50°C
Storage Temperature	-20°C ~ 60°C
Operating Humidity	20% ~ 80% RH, non-condensing
Mounting	VESA 400 mm x 400 mm
Dimension (W x H x D)	1247.6mm x 78.8mm x 732.4mm
Net Weight	30.75 kg
Gross Weight	37.21 kg

1.4 Block Diagram

This section describes the electrical requirements of the monitor. The block diagram in figure 1 illustrates the various electrical sub-systems.

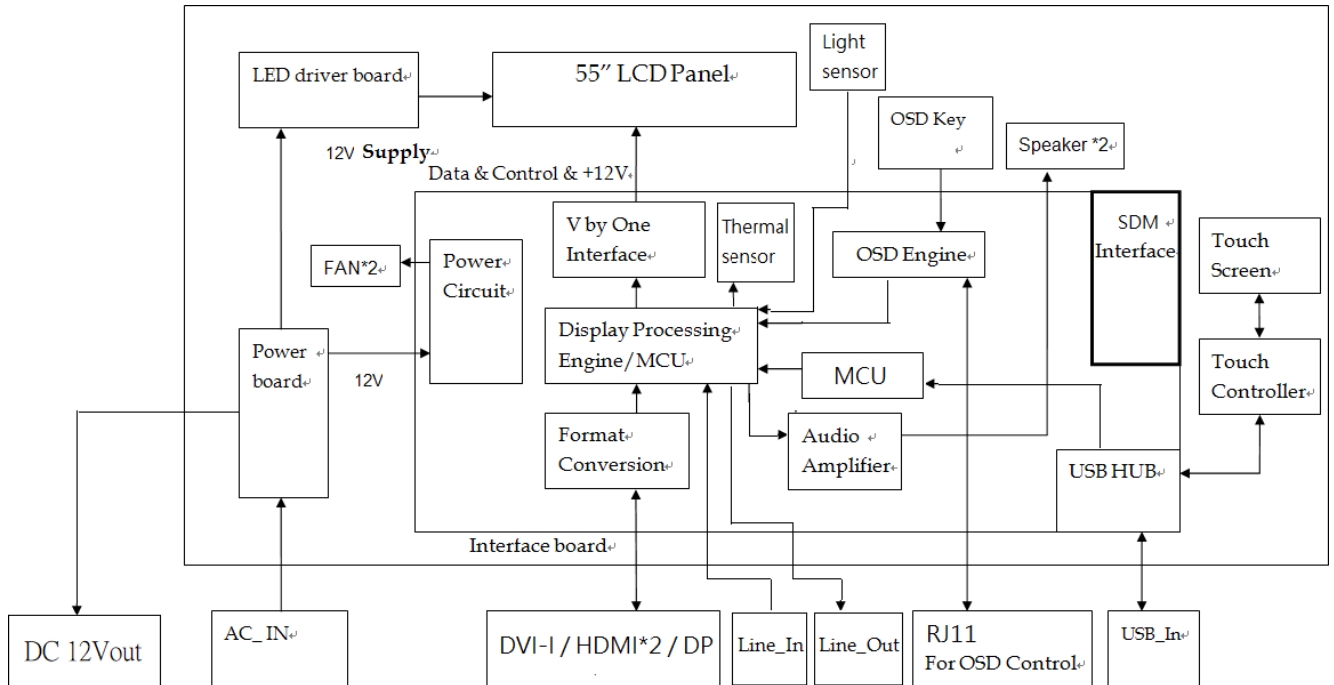

1.5 Interface Connectors

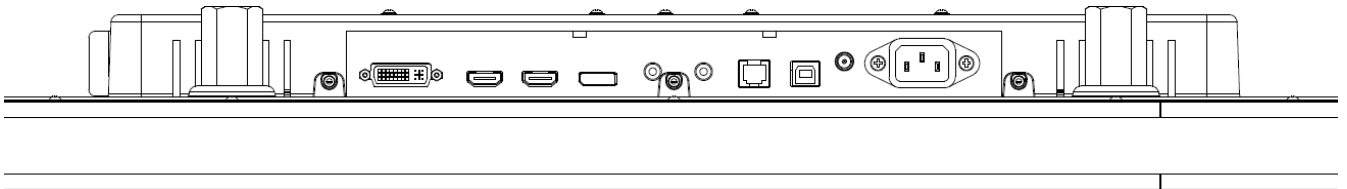

1.5.1 Power Connector

The AC converter shall have an IEC320 type male power receptacle for connection to AC mains power. The power cord, exact type to be supplied in the appropriate Option Kit, shall be length of 1.8 ± 0.05 meters, and PC99 compliant.

1.5.2 Video Signal Connector

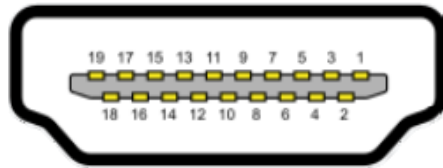

The video signal input via HDMI female connector.
Connector Pin Assignment:

Pin	Signal	Pin	Signal
1	TMDS Data2+	11	TMDS Clock Shield
2	TMDS Data2 Shield	12	TMDS Clock-
3	TMDS Data2-	13	CEC
4	TMDS Data1+	14	Reserved (N.C. on device)
5	TMDS Data1 Shield	15	SCL
6	TMDS Data1-	16	SDA
7	TMDS Data0+	17	DDC/CEC Ground
8	TMDS Data0 Shield	18	+5V Power
9	TMDS Data0-	19	Hot Plug Detect
10	TMDS Clock+		

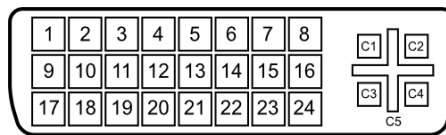

The video signal input via DVI female connector.
Connector Pin Assignment:

Pin	Signal	Pin	Signal
1	TMDS Data 2-	16	Hot Plug Detect
2	TMDS Data 2+	17	TMDS Data 0-
3	TMDS Data 2/4 Shield	18	TMDS Data 0+
4	TMDS 4-	19	TMDS Data 0/5 Shield
5	TMDS 4+	20	TMDS Data 5-
6	DDC Clock	21	TMDS Data 5+
7	DDC Data	22	TMDS Clock Shield
8	Analog vertical sync	23	TMDS Clock+
9	TMDS Data 1-	24	TMDS Clock-C1
10	TMDS Data 1+	C1	Analog red
11	TMDS Data 1/3 Shield	C2	Analog green
12	TMDS 3-	C3	Analog blue
13	TMDS 3+	C4	Analog horizontal sync
14	+5V DDC Power	C5	Analog ground Return for R, G, B signals
15	Gnd (+5, Analog V/H Sync)		

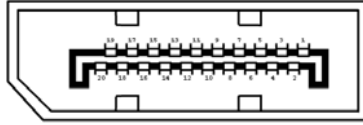

The video signal input via Display Port (1.2) connector.
Connector Pin Assignment:

Pin	Signal
1	ML_Lane 3(n) Data3 -
2	Signal ground
3	ML_Lane 3(p) Data3 +
4	ML_Lane 2(n) Data2 -
5	Signal ground
6	ML_Lane 2(p) Data2 +
7	ML_Lane 1(n) Data1 -
8	Signal ground
9	ML_Lane 1(p) Data1 +
10	ML_Lane 0(n) Data0 -
11	Signal ground
12	ML_Lane 0(p) Data0 +
13	Signal ground
14	Signal ground
15	AUX_CH(p) AUX + Signal for Auxiliary Channel
16	Signal ground
17	AUX_CH(n) AUX - Signal for Auxiliary Channel
18	Hot Plug
19	DP_PWR Return
20	DP_PWR

1.5.3 Signal Connector

	Pin	Description
	1	VCC
	2	D-

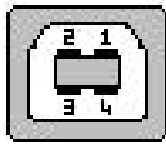

USB Connector

3	D+
4	GND

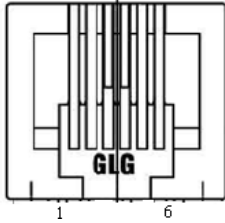



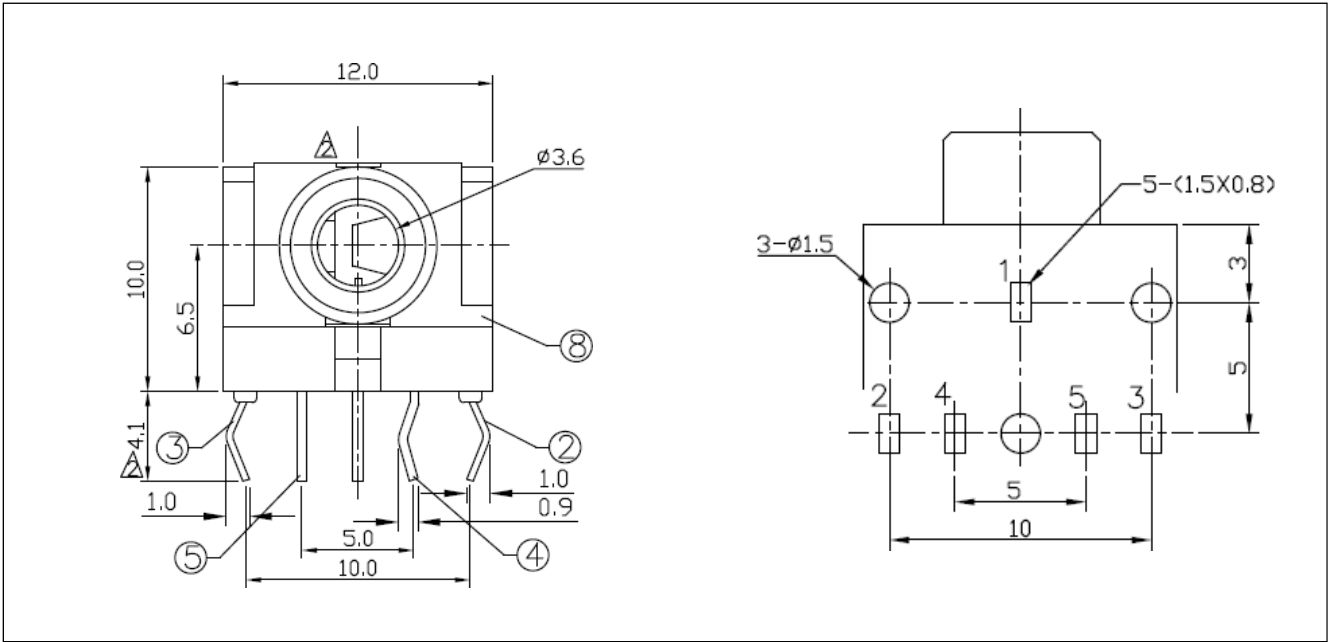

RJ11 Connector (Remote Key)

Pin	Description
1	MENU
2	UP
3	DOWN
4	SELECT
5	POWER
6	GND

Audio Line in / Line out connector

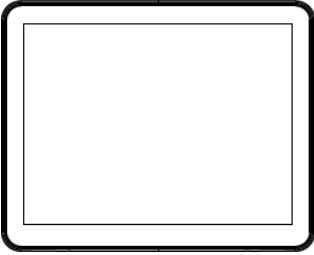
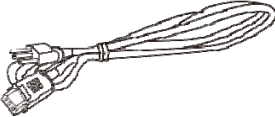
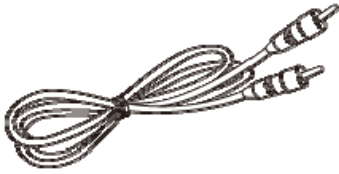
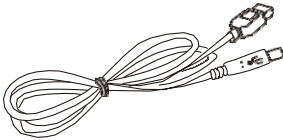

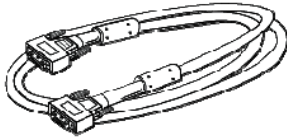
1.6 Package Overview

		
<p>LCD Display</p>	<p>Power Cord</p>	<p>Audio cable</p>
		
<p>USB Cable (A to B)</p>	<p>HDMI Cable</p>	<p>DVI to VGA cable</p>
		
<p>Screw (M4) x 20 pcs</p>		

Warning!

This product is intended to be supplied by an AC-in Power source, rated 100V~240V, 1.8~0.8A 50/60Hz minimum, T_{ma} = 40 degree C minimum, and the altitude of operation = 5000m minimum. If it needs further assistance with purchasing the power source, please contact to Element for further information.

Chapter 2

Product Installation

2.1 About VESA Mount

The M55-4K series conform to the “VESA Flat Display Mounting Interface Standard” which defines a physical mounting interface for touch monitor and corresponding with the standards of touch monitor mounting devices. The VESA mount is located on the back of this unit.

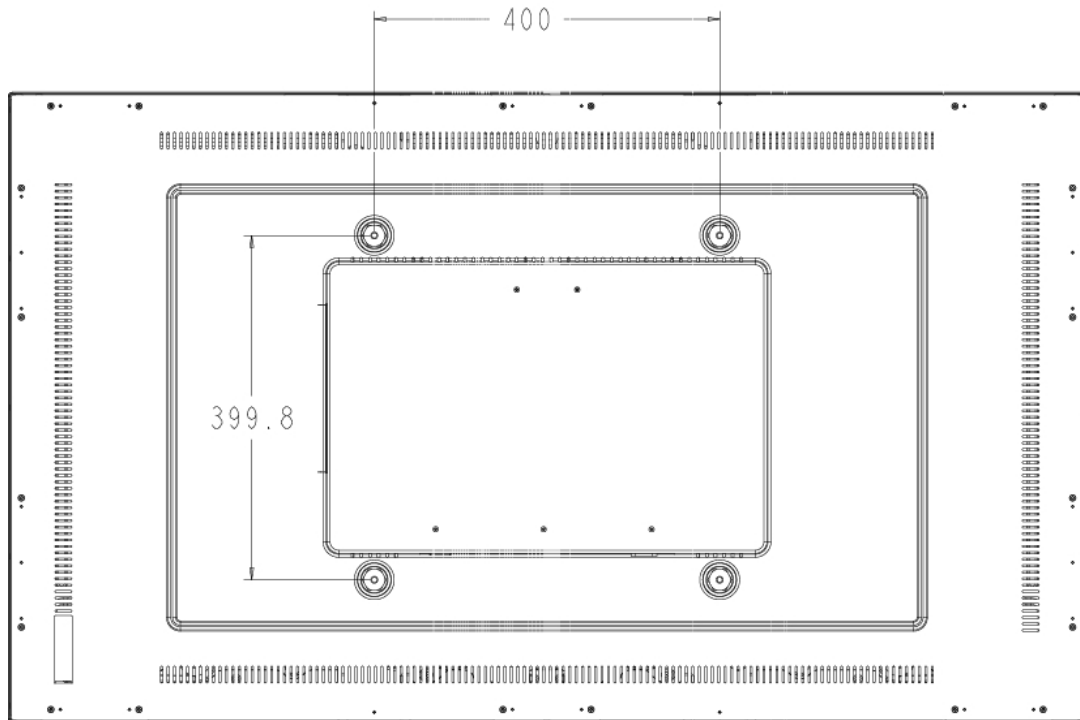

Warning!

***Please select the Element original screws!
The distance between the back cover surface and the bottom of the screw hole is 6~7mm. Please use M6 8mm screws diameter with proper length to mount your monitor.***

2.1.1 Install the VESA screw

Note: Please install/ dismantle the product when the device is in the shutdown state. Step 1:

Fasten four screw nuts into the VESA hole

The specification of the screw nut is M6 x 8mm, the length of nut is 43mm Step 2:

Fasten four M6 screws into the screw nut

The specification of the screw is M6 x 30mm

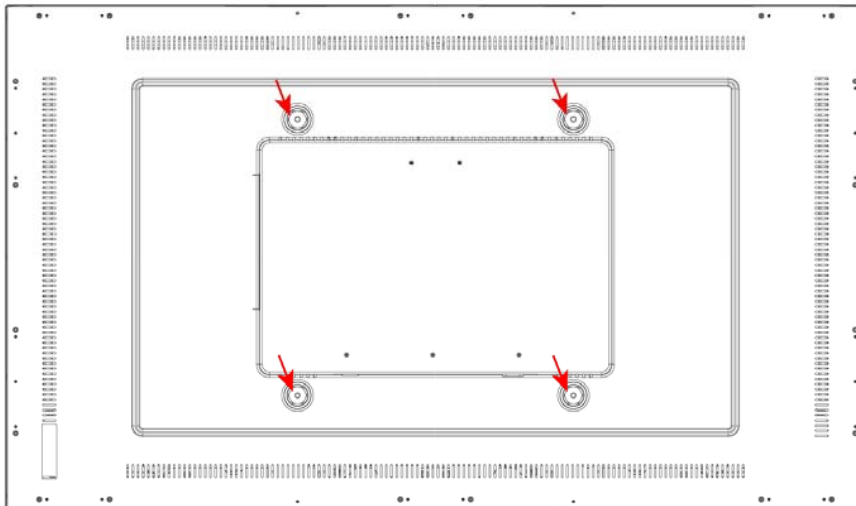

2.2 About General Mounting Information

The following two mounting orientations are supported: Landscape and portrait mode. For optimal touch performance, ensure that the monitor is supported fully and is as flat as possible.

2.2.1 Landscape

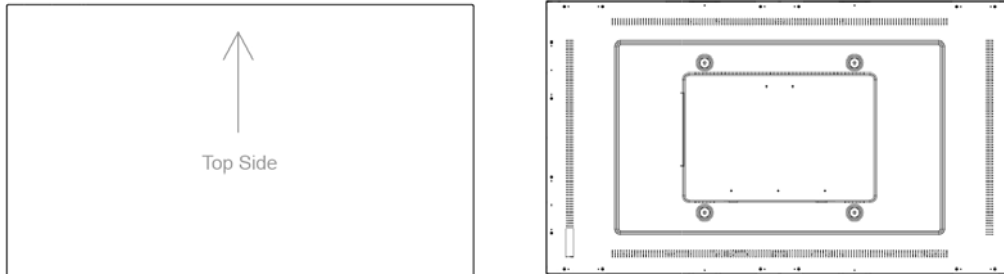

2.2.2 Portrait

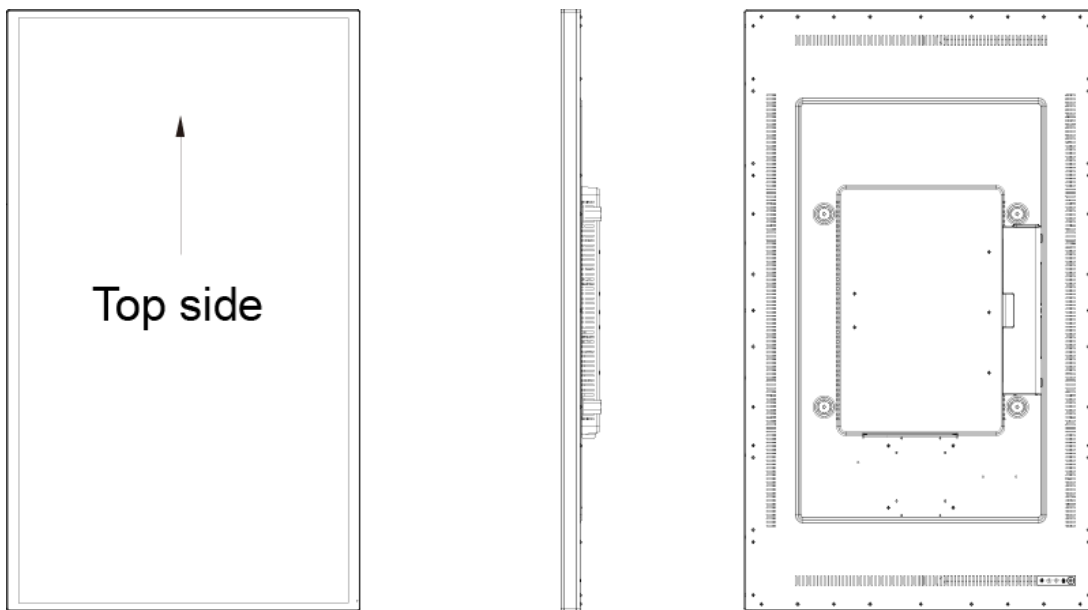

2.3 On-Screen Display

The M55-4K Lite series provide side panel controls. And the following is OSD function table:

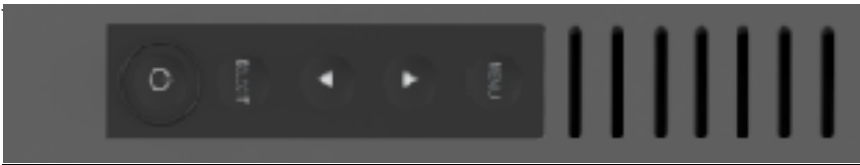

Key	OSD	Menu off status	Menu on status
	MENU	Menu appear	Menu disappear/ return to main item
	▲	N/A	Main item select up/ Adjust up
	▼	N/A	Main item select down/ Adjust down
	SELECT	N/A	Enter/Select sub-item function
	⏻	Power On/Off	
	MENU+▲	Enter Factory Menu	N/A
	MENU+▼	Enter Lock Menu	N/A

1. Press the “MENU” button to pop up the “on-screen menu” and press “Up” or “Down” button to select among the five functions in the main menu.
2. Choose the sub-menu page by pressing the “SELECT” button, and press “Up” or “Down” button to select the adjustment items in the sub-menu.
3. Pressing “SELECT” button for the selected adjustment items and adjust the value by pressing the “Up” or “Down” button.
4. With the OSD menu on screen, press “Menu” button to return main menu or exit OSD.
5. The OSD menu will automatically close if you have left it idle for a pre-set time. When Monitor enters sleep mode, Press “MENU” button & SELECT” button to wake monitor up and enter source input mode
6. To Lock / Unlock the OSD / Power menu buttons, press “Menu” and “Minus” at the same time to Select OSD / Power the Lock / Unlock function.

Please note:

- a. When the OSD Lock function is selected, this indicates that all the buttons except “power” button are now disabled.
- b. When the Power Lock function is selected, this indicates that the power key is disabled; user can not
- c. When the OSD Lock is selected, the “Locking Key” be displayed on screen when the any key is pressed. You need to press “Menu” and “Minus” again. The Lock menu screen will appear.
- d. When the Power Lock is selected, the “Locking Key” be displayed on screen when the Power key is pressed. You need to press “Menu” and “Minus” again. The Lock menu screen will appear.

2.3.1 OSD Function Description

Item	Content	Default
Contrast	The monitor luminance level control.	50
Brightness	The monitor backlight level control.	100
Auto Adjust	Fine-tune the image to full screen automatically.	NA
Left/Right	Moving screen image horizontal position to left or right.	NA
Up/Down	Moving screen image vertical position to up or down.	NA
Horizontal size	The screen image horizontal dot clock adjustment.	NA
Fine	The screen image pixel phase adjustment.	NA
OSD Left/Right	Moving OSD menu horizontal position to left or right.	50
OSD Up/Down	Moving OSD menu vertical position to up or down.	50
OSD Time out	OSD auto-disappear time selection.	15
OSD Language	OSD menu language selection. (English, French, Japanese, Deutsch, Spanish, Italian, Traditional Chinese and Simplified Chinese)	English
Factory Reset	Factory default value restored.	NA
RGB	Color temperature selection. (5500K, 6500K, 7500K, 9300K, User)	User
Volume	Audio volume adjustment.	50
Mute	Audio On/Off control.	Off
Input select	Input select function. (Auto, DVI-A, DVI-D, HDMI2, HDMI1, DP, SDM)	Auto

2.3.2 Timing Table Chart

Mode	Resolution	H-Freq. (KHz)	Bandwidth (MHz)	Polarity	
				H	V
1	VGA 640x480 60Hz	31.47	25.175	-	-
2	VESA 800x600 60Hz	37.88	40	+	+
3	VESA 1024x768 60Hz	48.36	65	-	-
4	VESA 1280x720 60Hz	44.772	74.5	-	+
5	VESA 1280x768 60Hz	47.776	79.5	-	+
6	VESA 1280x1024 60Hz	64	108	+	+
7	VESA 1280x960 60Hz	60	108	+	+
8	VESA 1440x900 60Hz	56	106.5	-	+
9	VESA 1360x768 60Hz	47.712	85.5	+	+
10	VESA 1680x1050 60Hz	65.2	146	-	+
11	FHD 1920x1080 60Hz	67.5	148.5	+	+
12	WUXGA 1920x1200 60Hz (RB)	74	154	+	-
13	WQHD 2560x1440 60Hz (RB)	88.787	241.5	+	-
14	UHD 3840x2160 30Hz	67.5	297	+	+
15	UHD 3840x2160 60Hz	135	594	+	+

2.3.3 EDID Data

DVI-A.DVI-D

The monitor assembly shall provide a display communications channel that conforms to VESA DDC2B hardware requirements. This configuration shall contain the 128-byte EDID file as specified by VESA EDID Standard.

HDMI 1.4, HDMI 2.0 & DP

The monitor assembly shall provide a display communications channel that conforms to VESA DDC2B hardware requirements. This configuration shall contain the 256-byte EDID file as specified by VESA EDID Standard

2.4 Dimension

2.4.1 Front View

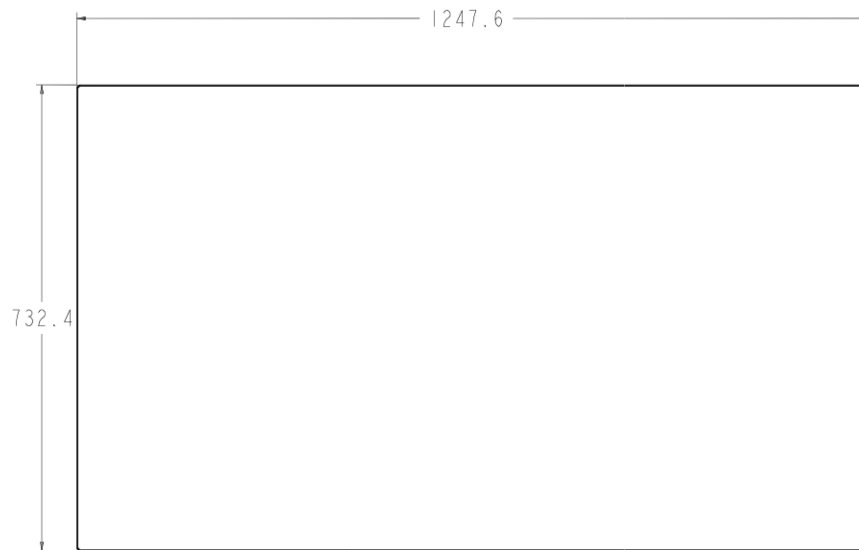

2.4.2 Side View

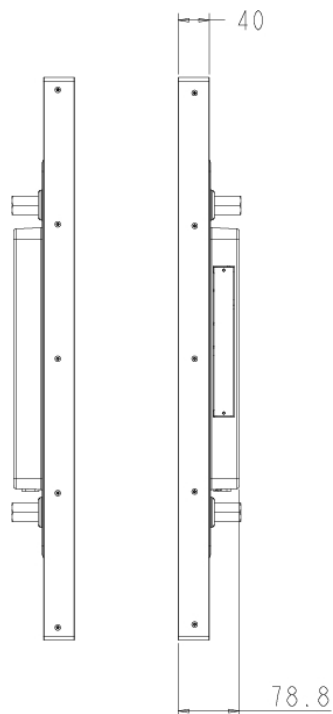

2.4.3 Rear View

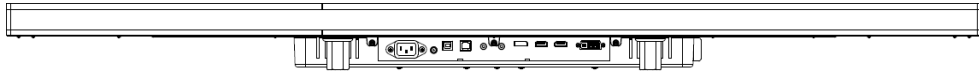

2.4.4 Back View

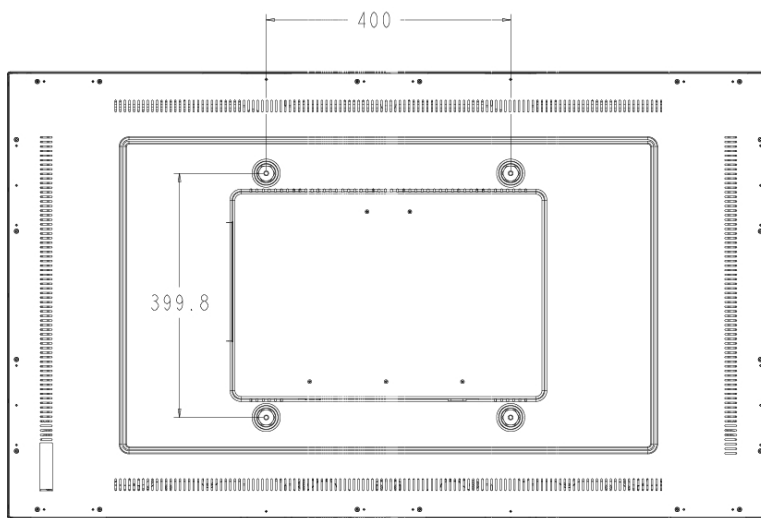

Appendix

Declaration of the Presence Condition of the Restricted Substances Marking

Equipment name: Touch Monitor		Type designation (Type) : M55-4K				
Unit	Restricted substances and its chemical symbols					
	Lead (Pb)	Mercury (Hg)	Cadmium (Cd)	Hexavalent chromium (Cr ⁺⁶)	Polybrominated biphenyls (PBB)	Polybrominated diphenyl ethers (PBDE)
Plastic Parts	○	○	○	○	○	○
Metal Parts	-	○	○	○	○	○
Cable component	-	○	○	○	○	○
LCD Panel	-	○	○	○	○	○
Touch Panel	-	○	○	○	○	○
PCBA	-	○	○	○	○	○
Software	○	○	○	○	○	○
<p>Note 1 : “Exceeding 0.1 wt %” and “exceeding 0.01 wt %” indicate that the percentage content of the restricted substance exceeds the reference percentage value of presence condition.</p> <p>Note 2 : “○” indicates that the percentage content of the restricted substance does not exceed the percentage of reference value of presence.</p> <p>Note 3 : The “-” indicates that the restricted substance corresponds to the exemption.</p>						