

element™

DESIGN. QUALITY. PURPOSE



ELEMENT CA850 MODULAR POS TOUCH TERMINAL



ELEMENT PRODUCT UPDATE

Element CA850 POS Terminal

| Element CA850

Element CA850 is the Next Generation in Point of Sale Terminals. The CA850 is a sleek and versatile 15.6" Point-of-Sale Terminal that helps provide the best customer experience for the retail & hospitality clients.

With its ultra slim body, attractive metallic design and number of flexible configurations, the CA850 carries out the transactions quickly and efficiently, helping build customer loyalty and growing your business.

- Borderless design with True Flat, P-Cap multi-touch technology
- Fanless design with either i3-7100U 2.4GHz, Elkhart Lake Celeron J6412, or Tiger Lake i3-1115G4 CPU
- 8GB RAM and 128GB M.2 SSD Storage.
- Modular design, reconfigure **one** product to **five** configurations
- Blade peripherals, 3-Track MSR, customer display options (CDU) & fingerprint available
- Standard 3-year warranty



ELEMENT PRODUCT UPDATE

Element CA850 POS Terminal

| Element CA850

The Element CA850 is built with industrial grade components designed from the ground up to support embedded processors. The result a POS terminal designed to be sleek and fashionable, whilst providing the power, performance and reliability needed for varied POS applications.

- Designed for industrial and commercial applications.
- Uses the long-term roadmap of Intel embedded chip sets.
- Built for the modern needs of fashionable retail environments.

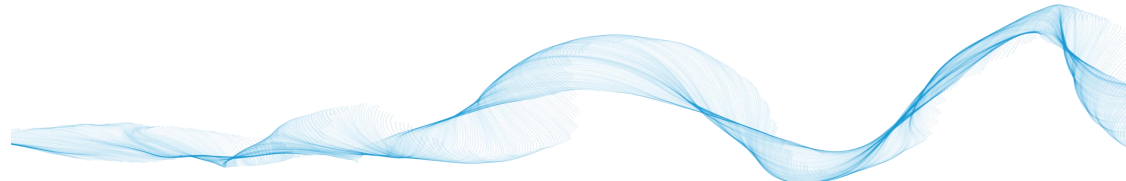

ELEMENT PRODUCT UPDATE

Element CA850 POS Terminal

Design

- Ultra Slim Body
- High Screen-to-Body Ratio
- Multiple Configurations
- Aesthetic Metallic Design



ELEMENT PRODUCT UPDATE

Element CA850 POS Terminal

| Design

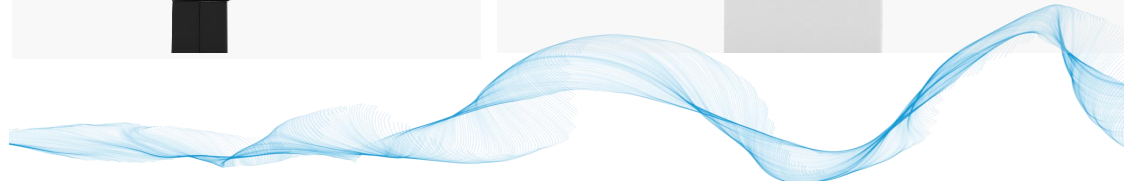

ELEMENT PRODUCT UPDATE

Element CA850 POS Terminal

| Design



13.4mm
NARROW

7mm THIN

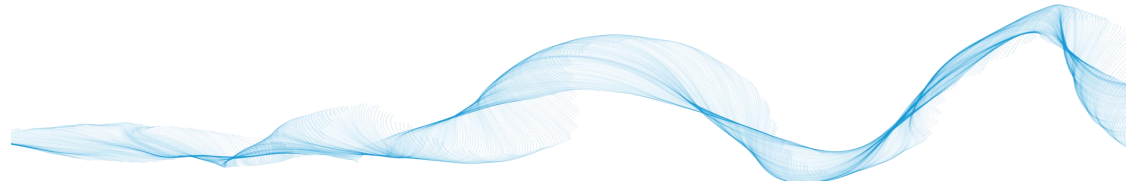
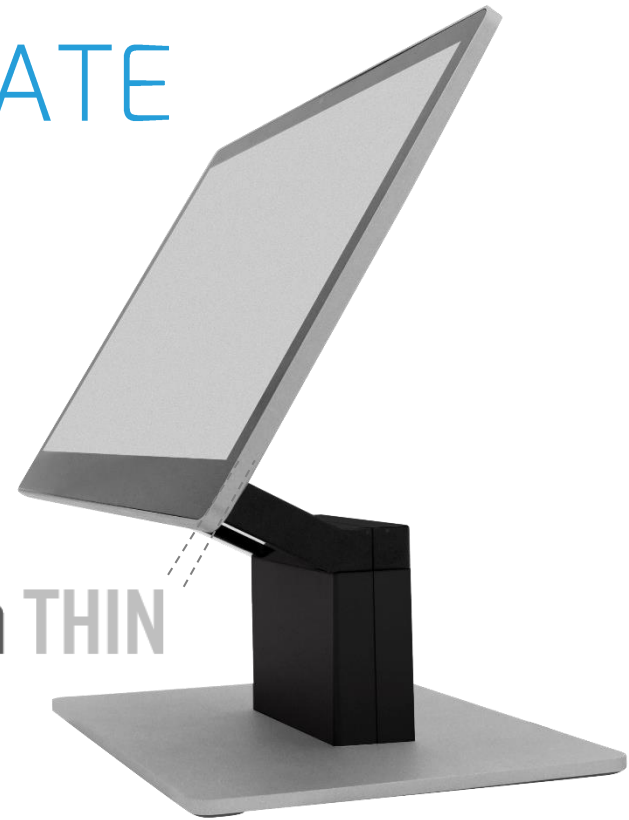

ELEMENT PRODUCT UPDATE

Element CA850 POS Terminal

Dimensions

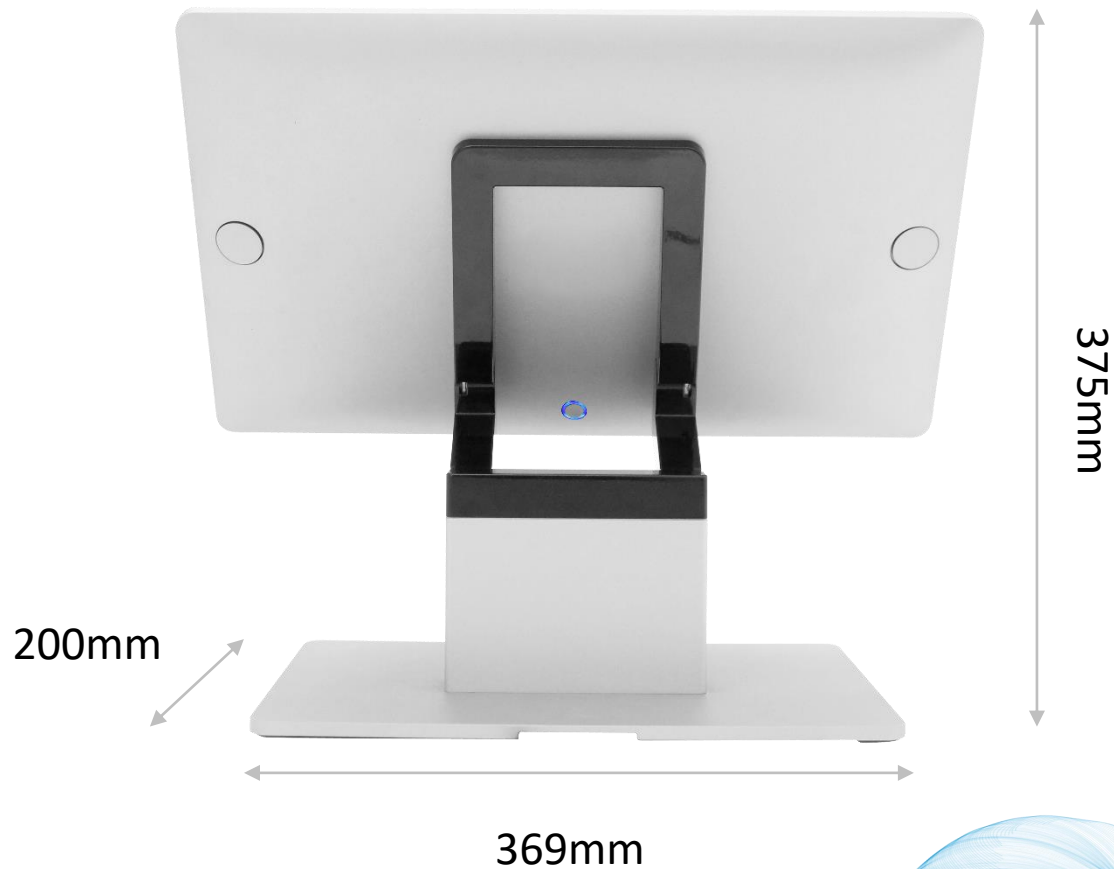

ELEMENT PRODUCT UPDATE

Element CA850 POS Terminal

| Modular Design



ELEMENT PRODUCT UPDATE

Element CA850 POS Terminal

Unique Display Port Cable

DP Cable

- Power / Video /Data
- Three Lengths Available
(46cm / 58cm / 200cm)



ELEMENT PRODUCT UPDATE

Element CA850 POS Terminal

Configurations

One Product, Five configurations, Unlimited applications

All-in-one



Hidden System Box

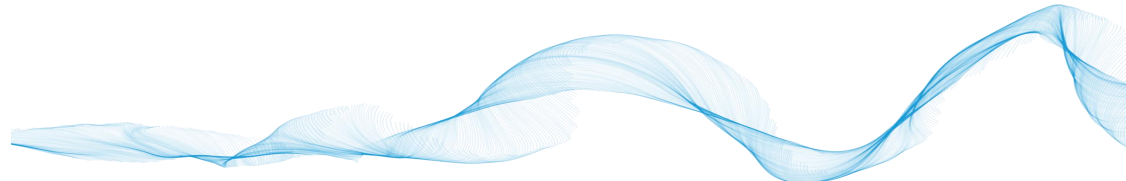

ELEMENT PRODUCT UPDATE

Element CA850 POS Terminal

Peripherals



ELEMENT PRODUCT UPDATE

Element CA850 POS Terminal

2nd Displays



LCM



10.1" 2nd Display



15.6" 2nd Display

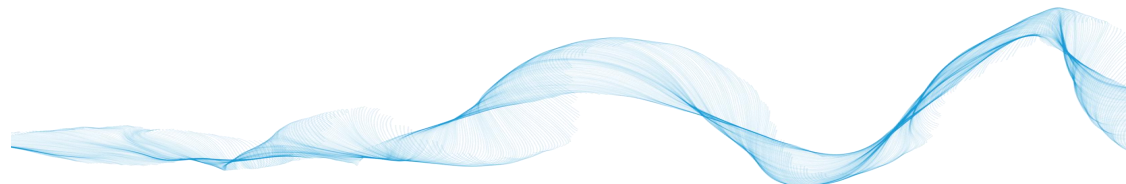

ELEMENT PRODUCT UPDATE

Element CA850 POS Terminal

Connectivity

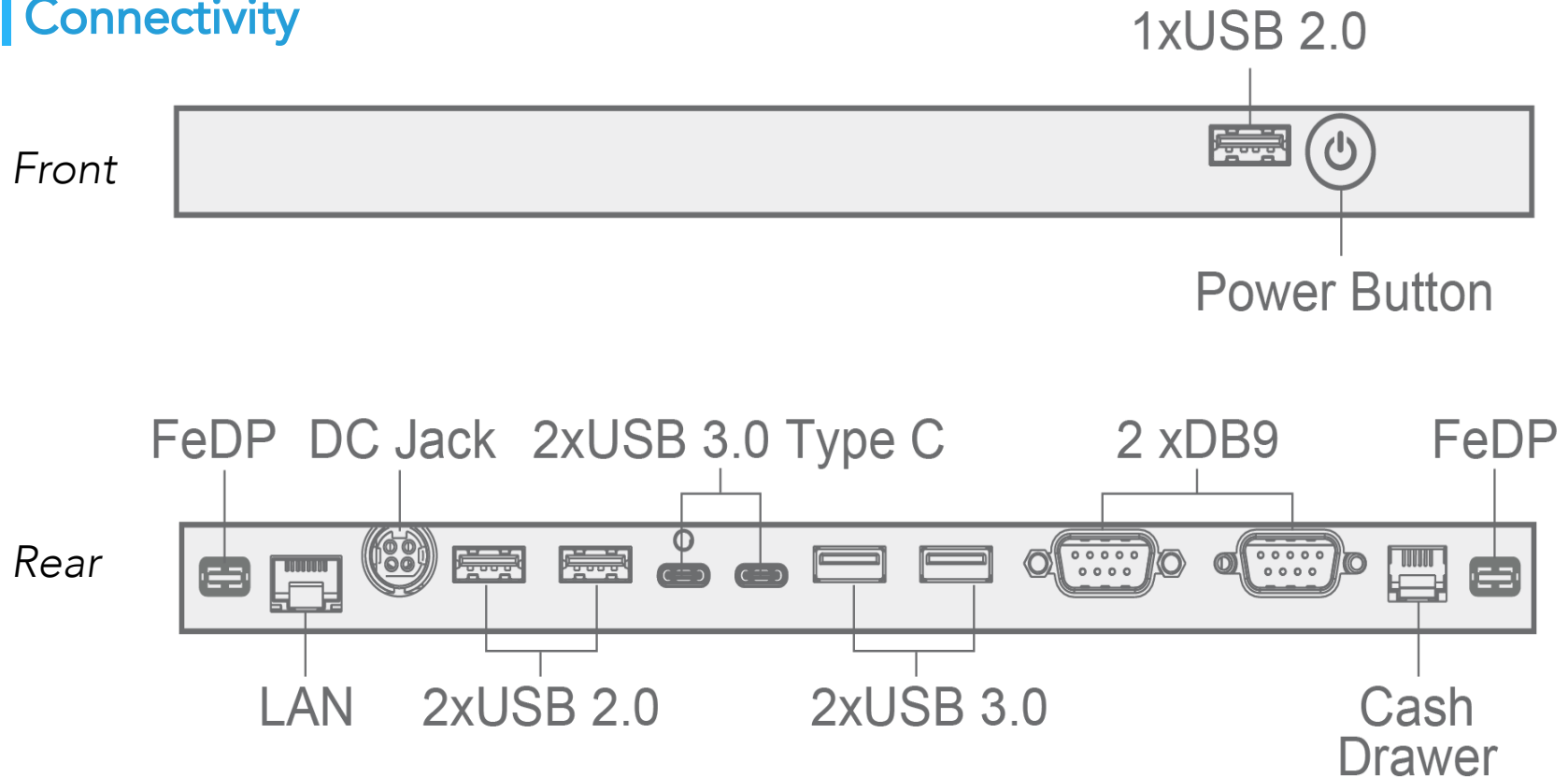

ELEMENT PRODUCT UPDATE

Element CA850 POS Terminal

Summary

Applications

Hospitality such as:

- Quick service restaurants
- Pubs
- Clubs
- Cafes

Fashion & Apparel

Grocery

Pharmacy

Petroleum

Industrial and commercial applications

Features

15.6" widescreen all-in-one POS Terminal

Borderless design with True Flat, P-Cap multi-touch technology

Fanless design with either i3-7100U 2.4GHz, Elkhart Lake Celeron J641, or Tiger Lake i3-1115G4 CPU

8GB RAM and 128GB M.2 SSD Storage.

Modular design, reconfigure **one** product to **five** configurations

Blade peripherals, 3-Track MSR, customer display options (CDU) & fingerprint available

Standard 3-year warranty

Unique Selling Points

Sleek and versatile

Ultra slim body

High Screen-to-Body Ratio

Attractive metallic design

Number of flexible configurations

Built with industrial grade components designed from the ground up to support embedded processors

Unique Display Port Cable

Carries out the transactions quickly and efficiently, helping build customer loyalty and growing your business.

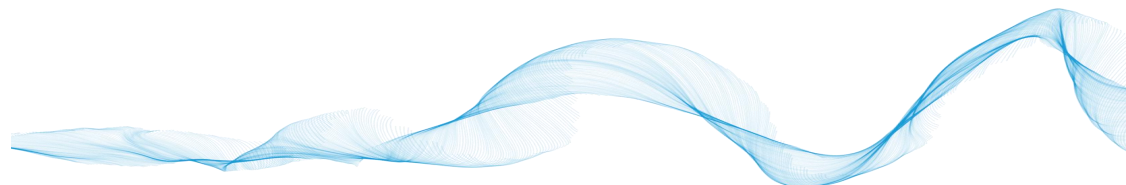

SPECIFICATIONS

	Model	CA850		
	Motherboard	D84U	F34	F84U
System	Processor	Intel KabyLake-U CPU i3-7100U 2.4GHz	Intel® Elkhart Lake Celeron J6412	Intel® Tiger Lake i3-1115G4
	Memory	8GB DDR4 (Max 16GB)		
	Storage	128GB SSD (M.2) (Max 512GB)		
	Size and Resolution	15.6" 1920x1080		
Display	Touch Screen	True-Flat PCAP multi-touch		
I/O Ports (Front Side)	USB Type-A	1x USB2.0		
I/O Ports (Rear Side)	USB Type-A	2x USB3.0, 2x USB2.0		
	USB Type-C	2x USB3.0 (data only)	1x USB.2.0 (data only) 1x USB 3.0 (data only)	1x USB 3.0 (data only) 1x USB 3.0 (full-featured)
	Serial Port	2x DB9 (default: 0V; COM1/COM2: 0V, 5V, 12V)		
	LAN	1x RJ45		
	Cash Drawer	1x RJ11		
	DC Jack	1x 4PIN (with latch)		
Audio	Internal Speaker	1x 3W (Option)		
Indicator	Power Button	1		
	Power LED	1		
Power	Power Adapter	120W / 19V	65W / 19V	120W / 19V
Communication	Wireless LAN + BT (Optional)	Wi-Fi + BT USB dongle (Option)		

*Product specifications and data are subject to change without notice (E&OE)

SPECIFICATIONS

System	Model	CA850		
		D84U	F34	F84U
Peripherals (Option)	MSR		3-Track MSR (USB)	
	Fingerprint		Fingerprint reader (USB)	
	NFC		NFC Reader	
	iButton		iButton (USB)	
	Scanner		2D Scanner	
	Customer Display		LCM display 2 x 20 characters (USB)	
	2nd Display		11.6" 2nd display (optional)	
	Powered USB		2x 12V Powered USB 1x 24V Powered USB	
Accessories (Option)	Cable		Converter cable for FeDP to VGA Converter cable for FeDP to HDMI	
	Thermal Solution		Heatsink kit	
Certificate	EMC & Safety		FCC Class A, CE Mark, LVD	
Environment	Operating Temperature		0°C ~ 35°C (32°F ~ 95°F)	
	Storage Temp.		-20°C ~ 60°C (-4°F ~ 140°F)	
	Humidity		20% ~ 85% RH non-condensing	
Dimensions	W x D x H		369 x 200 x 375 mm (14.5" x 7.9" x 14.8")	
Weight	Weight (Kg)		5.4kg (11.9lbs)	
OS Supported			Windows 10 IoT Enterprise, Linux	
Warranty			36 Months	

*Product specifications and data are subject to change without notice (E&OE)

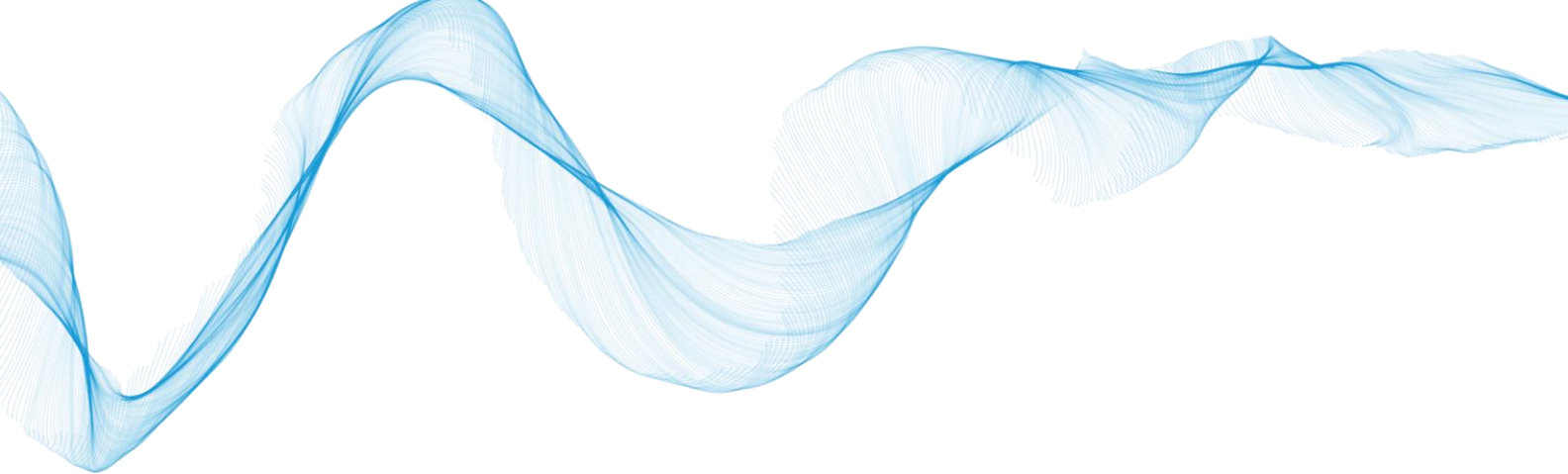

elementTM

www.elementpos.co